

## T41 Keyboard, Trackpoint, and Touchpad Controller using a Teensy 4.0

The picture below shows a Teensy 4.0 on a circuit board with a T41 keyboard connector. A smaller board has a T41 touchpad connector with wires back to the Teensy. The Teensy is programmed to scan the keyboard, then poll the trackpoint and touchpad over PS/2. The resulting keyboard and cursor movements are sent back to the host computer over USB. All files for this project are located at my [GitHub repository](#).

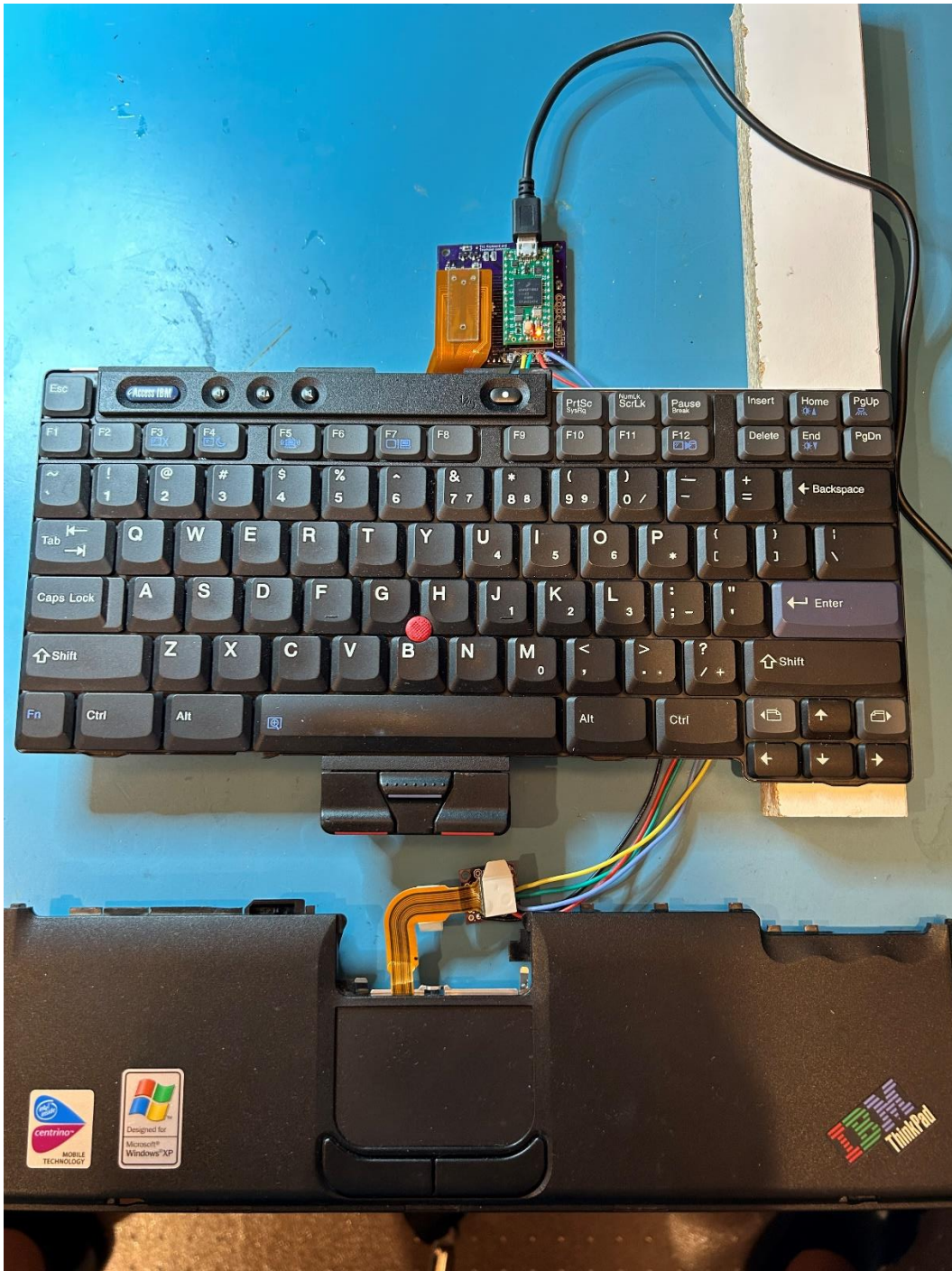

The keyboard backside with the trackpoint signals is shown below. Wires could be soldered to the trackpoint signal pads for standalone operation.

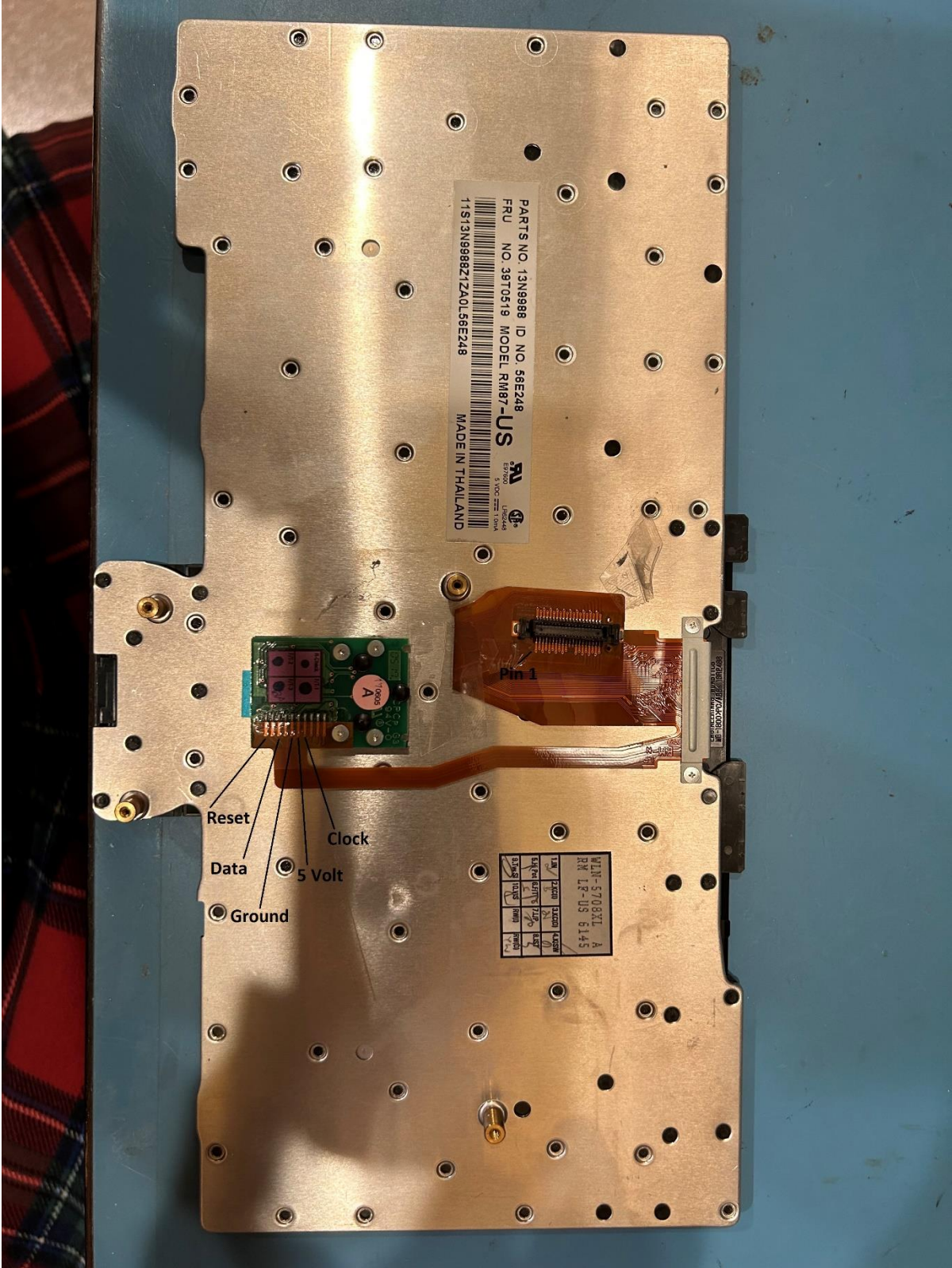

The picture below shows the Teensy 4.0 keyboard connector board as depicted by OSH Park.

The Eagle file "T41.brd" can be sent to OSHPark.com for fabrication or the zipped Gerber file "T41\_2023-08-24.zip" can be sent to any board fabricator including JLCPCB.com

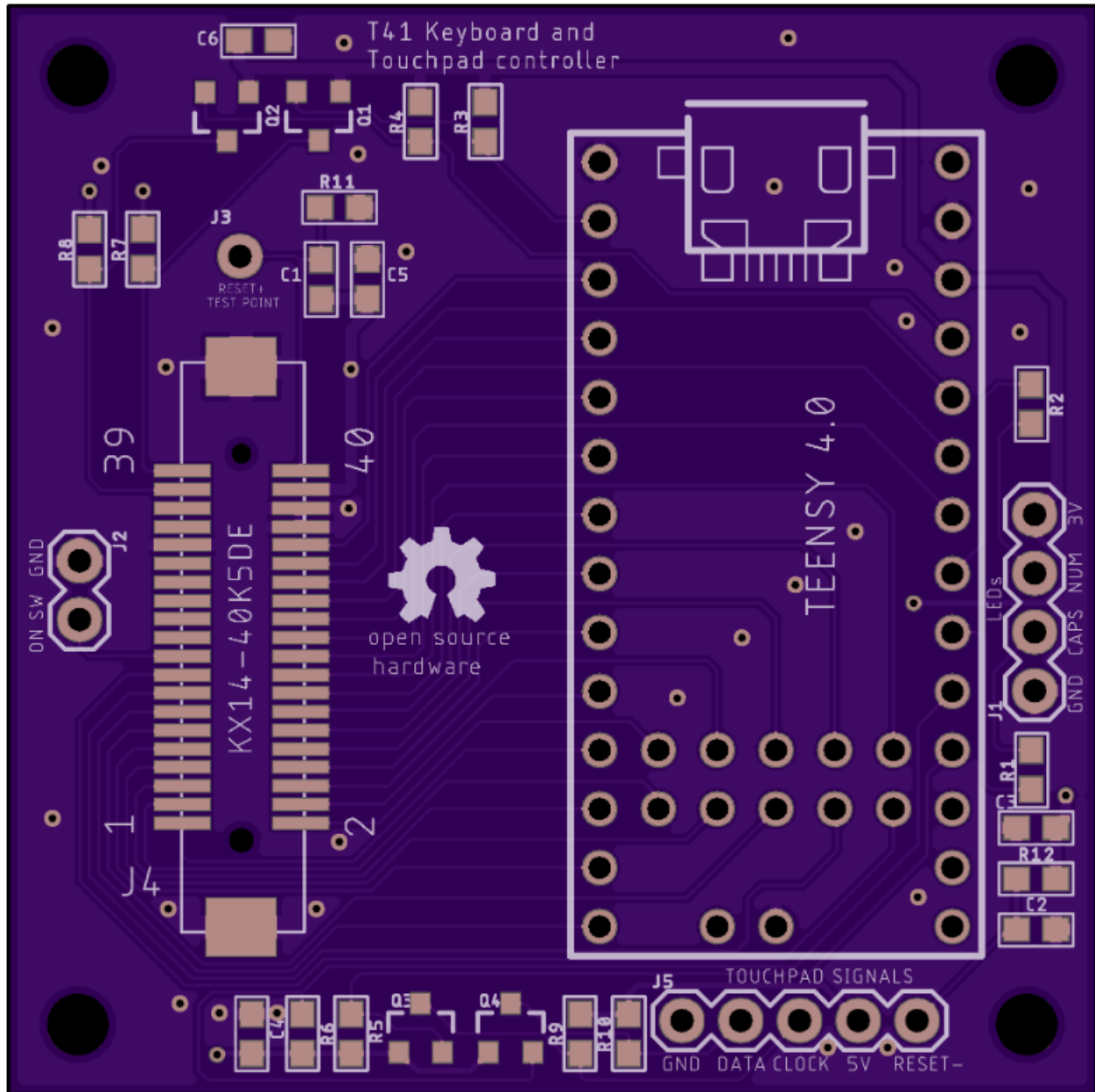

The keyboard connector is no longer available for purchase so it must be unsoldered from the motherboard. The easiest way to do this is with a heat gun or low cost [hot air rework station](#). First use a soldering iron to apply flux and [Chip Quik](#) removal alloy on all the connector legs and ground tabs. Then stand the motherboard on edge in a vise and blow hot air on the connector from the back side. The board will protect the connector from damage and the heat will transfer thru the board to the connector legs and tabs. When the solder goes molten, use needle nose pliers to gently lift the connector from the board. Clean up all the legs with flux and solder wick, then add some regular solder to each leg and remove it again with flux and solder wick.

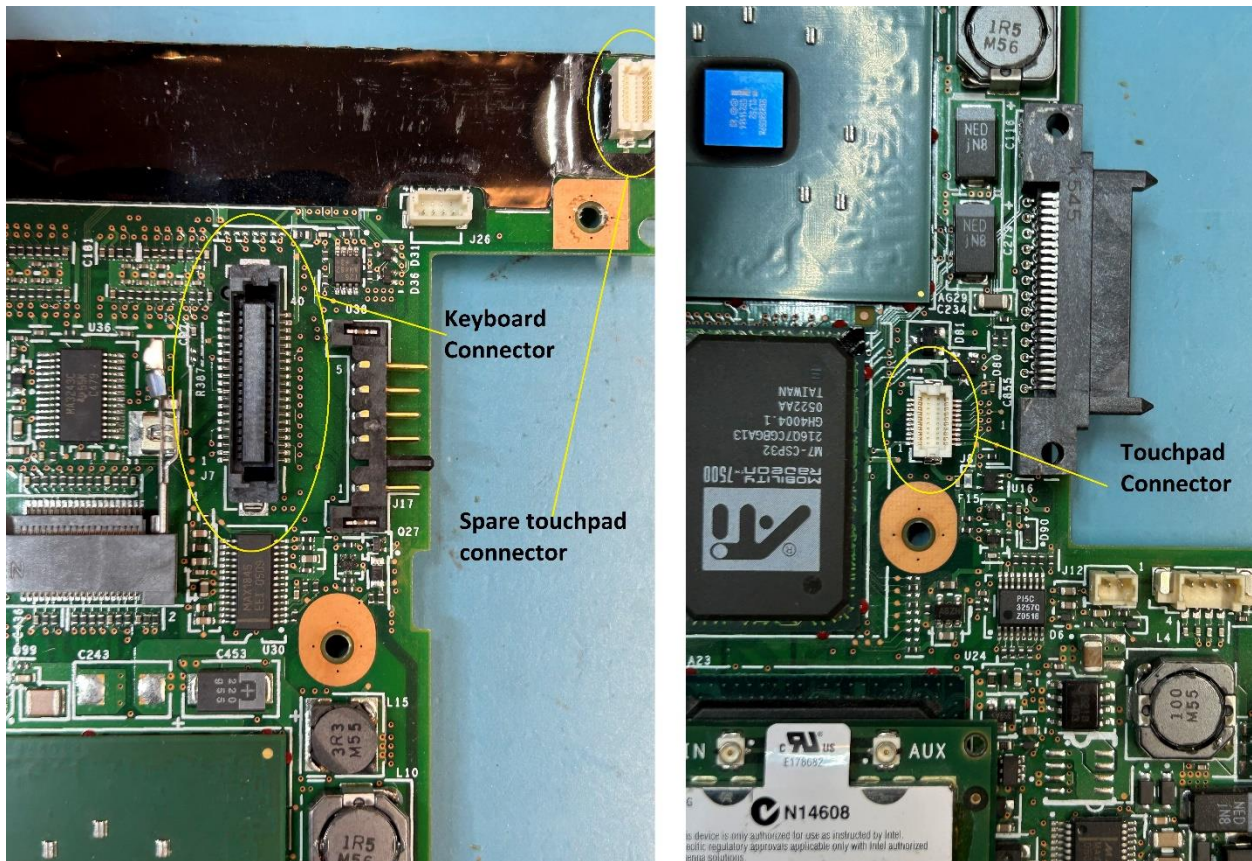

There are two DF12NB(5.0)-20DP-0.5V(51) connectors on the motherboard. One is for the touchpad and the other for something else. You could unsolder this connector to perfect your methods and avoid having to buy one.

The keyboard and touchpad connectors have posts that guarantee they can't be installed wrong. The circuit boards I've designed have holes for these keying posts. An added benefit is the posts hold the connector legs perfectly on the surface mount pads for soldering.

To assemble the board, you can solder all the surface mount components by hand with an iron but I prefer to use a [stencil](#) to apply solder paste and then flow the solder with my [converted toaster oven](#). Once the SMDs are soldered, prepare the Teensy by soldering flying leads or right angle header pins to the backside I/O pads. The final step is to solder the Teensy to the board with an iron.

This picture shows the connector board after being assembled. 2ma CAPS and NUM lock LEDs can be added as well as connecting the power switch to a turn-on circuit.

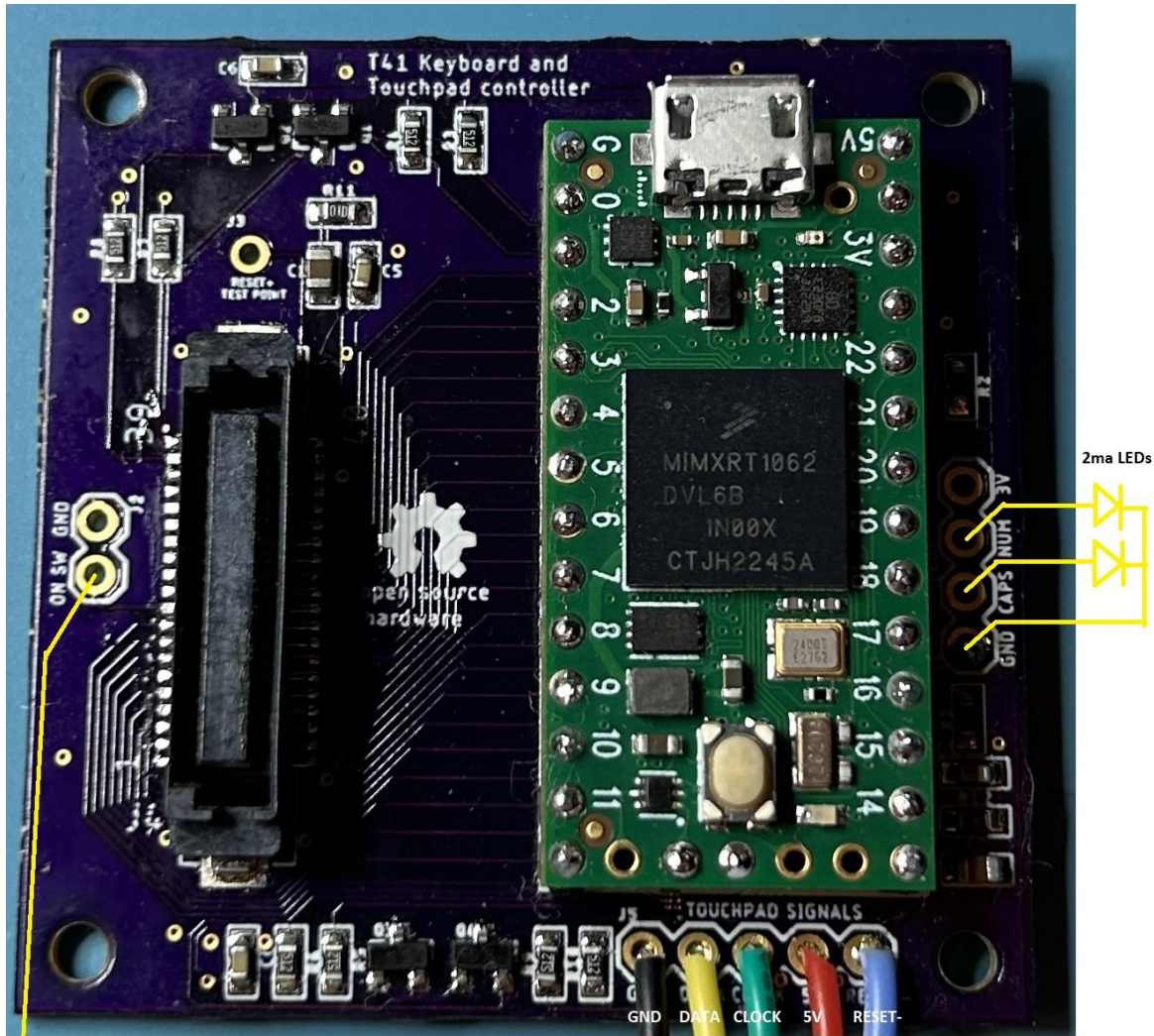

wire to power turn on circuit

wires to touchpad breakout board

Parts List:

Qty	Description
1	Teensy 4.0 with pins and flying leads or <a href="#">2x7 right angle header pins</a> for the backside I/O
4	0.1uf 0603 10V 10% ceramic caps
2	2.2uf 0603 10V 10% ceramic caps
8	4.7K 0603 1% 0.1 W thick film resistors
1	17K 0603 1% 0.1 W thick film resistor
1	100K 0603 1% 0.1 W thick film resistor
2	715 ohm 0603 1% 0.1 W thick film resistors
4	BSS138 N Channel FETs Digikey part number <a href="#">4530-BSS138CT-ND</a>
1	KX14-40K5DE keyboard connector unsoldered from the T41 laptop motherboard
1	Printed circuit board from Eagle file T41.brd or zipped Gerber file T41_2023-08-24.zip

The Teensy connector board schematic "T41.sch" is given below. The trackpoint needs a positive reset pulse at power up, provided by R11 and C1 and can be monitored at the RESET+ test point. The touchpad needs a negative reset pulse at power up provided by R12 and C2 and can be monitored at J5 pin 5 labeled RESET-.

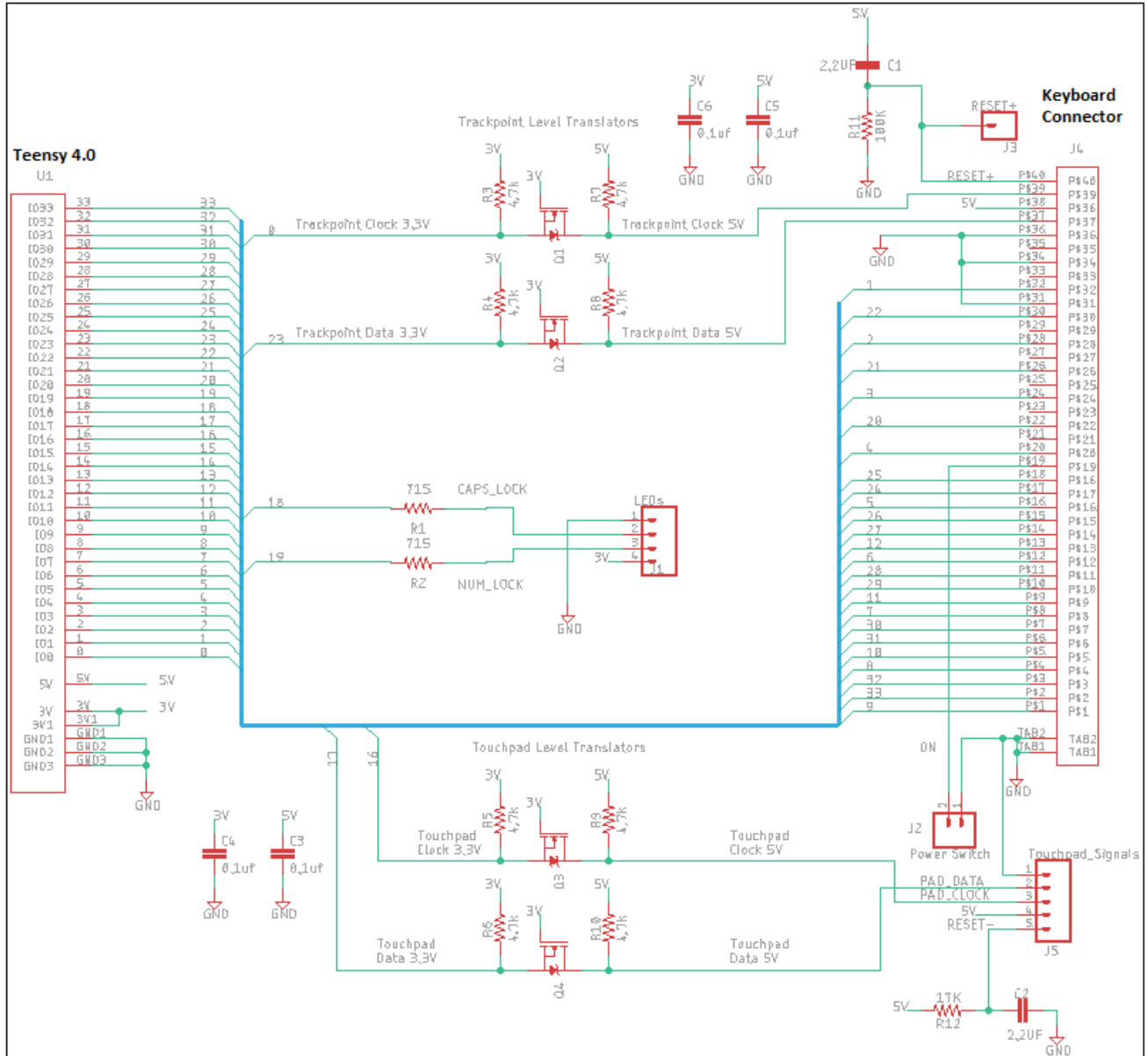

The Teensy I/O's are wired to the keyboard connector KX14-40K5D1 and touchpad per the table below.

<b>KX14_40K5D1</b>	<b>Teensy I/O</b>	<b>Description</b>
1	9	Fn Hot Key
2	33	Row Output
3	32	Column Input
4	8	Row Output
5	10	Column Input
6	31	Row Output
7	30	Column Input
8	7	Row Output
9	11	Column Input
10	29	Row Output
11	28	Column Input
12	6	Row Output
13	12	Column Input
14	27	Row Output
15	26	Column Input
16	5	Row Output
17	24	Column Input
18	25	Row Output
19		Power Switch (available at jumper pad J2-2)
20	4	Row Output
21		NC
22	20	Row Output
23		NC
24	3	Row Output
25		NC
26	21	Row Output
27		NC
28	2	Row Output
29		NC
30	22	Row Output
31		GND
32	1	Row Output
33		NC
34		GND
35		NC
36		GND
37	23	Trackpoint Data (level translated)
38	Vin	5 Volts (from USB)
39	0	Trackpoint Clock (level translated)
40		Trackpoint positive Reset (created using Resistor & Cap)
	16	Touchpad Clock (level translated)
	17	Touchpad Data (level translated)
	18	CAPS Lock to 2ma LED anode. LED cathode to ground
	19	NUM Lock to 2ma LED anode. LED cathode to ground
	13	Teensy on-board LED used for heartbeat
	14	Spare I/O
	15	Spare I/O

The file "Matrix\_Decoder\_T41.ino" was loaded into the Teensy and each key was pressed to give the I/O connections given in file "T41\_keyboard\_decoded.txt". The results from that list have been converted to the T41 keyboard matrix shown below. This matrix has been added to the file "IBM\_T41\_Keyboardandtouchpad.ino". This Teensy code scans the keys by driving each output row low, one at a time. The other 15 row outputs are left floating so they don't interfere. The Teensy enables internal pull ups on the 8 inputs so it will read a low if the key is pressed. The keyboard scan rate is approximately 30msec.

The Fn "Hot" key is not part of the matrix and has a dedicated connection to Teensy I/O 9. The other side of the Fn switch goes to ground. I/O pin 9 is programmed to be an input with a pullup so the Teensy can detect a logic low when pressed.

After the keyboard scan, the Teensy polls the touchpad and trackpoint with two separate PS/2 busses. If the trackpoint has movement or button changes, this information is sent over USB. If the trackpoint is not active, any touchpad movement or button changes are sent over USB.

T41 Keyboard Matrix

I/O #	10	11	12	24	26	28	30	32
1		Scr1-lock	prntscrn	alt-r				alt-l
2	home		end	left	pause			up
3	Pg-up		Pg-dn	Page-rt	Page-left			
4	ins		F12	right				
5	del	Vol+	F11	down		mute	Vol-	AccessIBM
6	-	p	0	/		;	[	'
7	F8	o	9		period	L	F7	
8	=	i	8		comma	k	]	F6
20	`	q	1		z	a	tab	esc
21					shift-r		shift-l	
22	cntrl-l				cntrl-r			
25	F1	w	2		x	s	Caps-lck	
27	F2	e	3		c	d	F3	F4
29	5	r	4	b	v	f	t	g
31	F9		F10	space	enter	\	bckspc	F5
33	6	u	7	n	m	j	y	h

Other items of note:

1. Pressing Fn and F2 will toggle the touchpad off/on. Likewise Fn and F1 will toggle the trackpoint off/on. If I'm using a mouse, I like to turn these off because my palm sometimes brushes the touchpad and moves the cursor. Also my typing sometimes grazes the trackpoint and moves the cursor.
2. The T41 keyboard doesn't have a Windows GUI key so I made the "Access IBM" key serve this purpose. There was no other use for "Access IBM" anyway.
3. Pressing Fn and Num Lock will toggle the embedded number pad on/off. If you are ever typing away and get numbers instead of JKLUIO, it's because the Num Lock was turned on.



4. Pressing the power button on the keyboard causes the pad labeled "ON SW" to be connected to the pad labeled "GND". The switch measures 10 ohms when pressed. This switch can be wired to a power supply latch circuit.
5. You can lengthen or shorten the wires from the Teensy board to the touchpad board. It's low frequency and is not prone to interference.
6. The LED on the Teensy blinks as a heartbeat indicator. If it's not blinking, the Teensy probably doesn't have USB power.
7. CAPS and NUM LOCK LEDs can be controlled by the Teensy. The Teensy connector board has 715 ohm current limit resistors for 2ma LEDs. If higher current LEDs are used, R1 and R2 will need to be changed. The LED anodes should be wired to the pads labeled "CAPS" and "NUM". Both LED cathodes should be wired to the pad labeled "GND". The code will provide 3.3 volts at the respective pads to turn on the LEDs.
8. The code prioritizes the trackpoint over the touchpad. If the trackpoint is moving the cursor, the touchpad is ignored, (the two are not added together).
9. The Page Back key acts like a Page Up key. The Page Forward key acts like a Page Down key.
10. During power up, the Teensy code tries to initialize the trackpoint over a "bit-bang" PS/2 bus. If the trackpoint fails its self-test, or gives no acknowledge, or causes a PS/2 bus time-out, a second attempt to initialize is made. If it still fails, the trackpoint is flagged as bad and no longer polled. The touchpad is initialized over a second "bit-bang" PS/2 bus in the same way. If the touchpad does not respond properly after two chances, it is flagged as bad and no longer polled.

The touchpad breakout board is designed to bring out the 20 signals from the DF12NB(5.0)-20DP-0.5V(51) connector for easy jumper wire attachment. The Eagle file “T41\_TPad.brd” or the Gerber file “T41\_TPad\_2023-08-24.zip” can be sent to the board house for fabrication. This is the OSH Park depiction of the board.

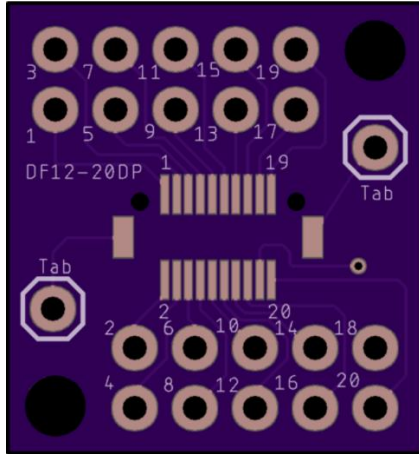

This table shows the touchpad connector pins and the corresponding “T” test points on the touchpad.

DF12-20DP	Touchpad	Description
1,10,20	T23	Ground
2	T22	5 Volts
4	T6	Touchpad Reset Active Low. Created by resistor and cap on Teensy board
6	T10	Touchpad Clock. Driven by Teensy I/O 16 thru level translator
8	T11	Touchpad Data. Driven by Teensy I/O 17 thru level translator
12	T8	TP4CLKPAD. Unused but must be pulled up with 100K to 5 volts
14	T9	TP4DATAPAD. Unused but must be pulled up with 100K to 5 volts
18	T5	BYPASS_PAD. Must be grounded

The signals TP4CLKPAD and TP4DATAPAD are inputs to the touchpad board and should be pulled up to 5 volts. With the BYPASS\_PAD signal grounded, these inputs are not used. The T41 motherboard used these signals to mux the touchpad PS/2 with the trackpoint PS/2. I’ve chosen to keep the touchpad and trackpoint PS/2 busses separately driven by the Teensy.

Parts List for the touchpad connector board:

Qty	Description
2	100K 1/10 watt 10% Axial Lead Resistors (value not critical)
1	DF12NB(5.0)-20DP-0.5V(51) connector
1	PCB from Eagle file T41_TPad.brd or zipped Gerber file T41_TPad_2023-08-24.zip

After soldering the DF12-20DP connector to the board, solder jumper wires to the Teensy connector board pads near the label, “Touchpad Signals” as described below:

- Jumper wire from pad labeled GND to the Touchpad board pin 20. This ties Teensy ground to touchpad ground.
- Jumper wire from pad labeled 5V to the Touchpad board pin 2. This provides 5 volt power to the touchpad.

- Jumper wire from pad labeled CLOCK to the Touchpad board pin 6. This PS/2 clock signal is level translated from Teensy I/O 16 for the 5 volt logic in the touchpad.
- Jumper wire from pad labeled DATA to the Touchpad board pin 8. This PS/2 data signal is level translated from Teensy I/O 17 for the 5 volt logic in the touchpad.
- Jumper wire from pad labeled RESET to the Touchpad board pin 4. This signal comes from a resistor and cap on the Teensy board that provides a logic low on power up to reset the touchpad.

On the touchpad connector board:

- Jumper pin 18 to 20 in order to tie the signal "BYPASS\_PAD" to ground.
- Add 100K resistor from pin 2 to 12. This pulls up unused input signal TP4CLKPAD.
- Add 100K resistor from pin 2 to 14. This pulls up unused input signal TP4DATAPAD.

The finished touchpad connector board with connections and resistors is shown below.

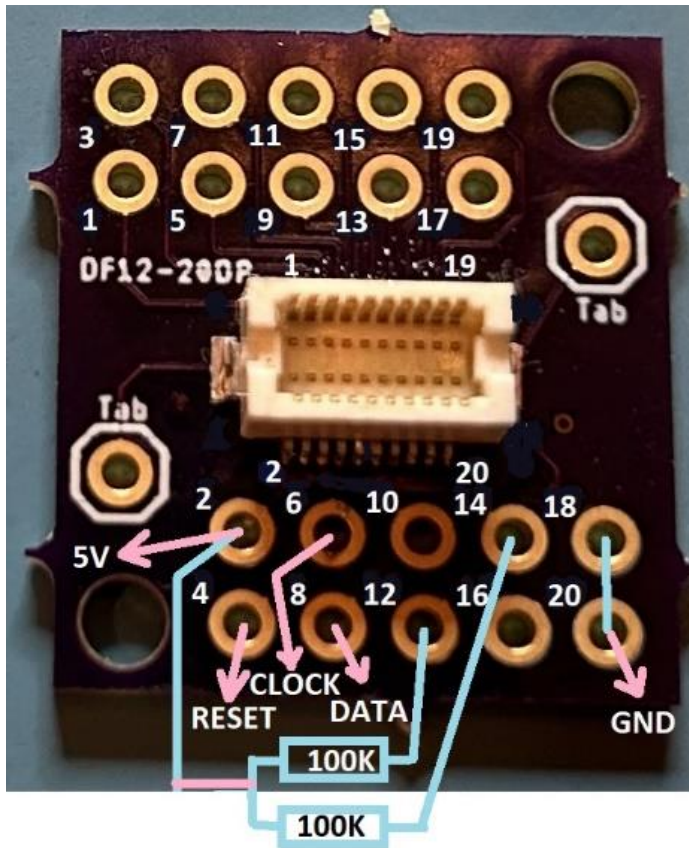

The picture on the left shows the TM42PUF2239 Synaptics touchpad circuit board attached to the palm rest. The picture on the right shows the “T” test points underneath the metal support. Wires could be soldered directly to these test points instead of using the 20 pin connector.

