

This project will show I made a USB keyboard and touchpad from repurposed laptop parts. All documentation can be found at my [Github repo](#). The keyboard is from a Toshiba 2415 laptop. The touchpad is from an HP DV9000 laptop. Both items can be found on Ebay.

This is the finished result.

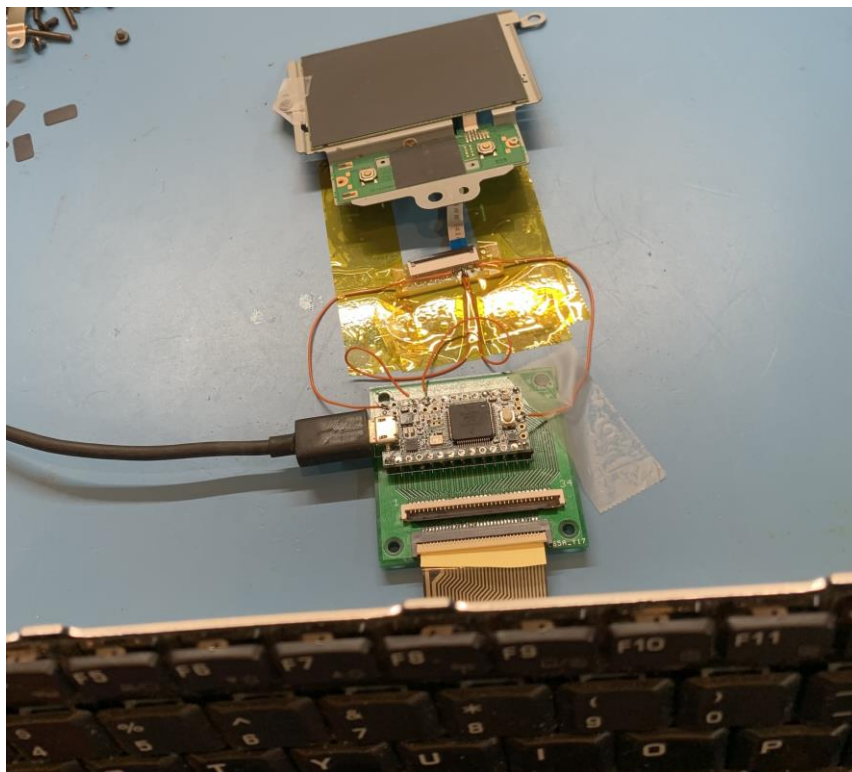

The keyboard was initially tested on the bench to decode the key matrix. I also got the touchpad from the Toshiba working as shown below but ended up using a touchpad from an HP DV9000 instead. The keyboard FPC cable is a little thick at the end and would not insert into the connector. I peeled off the plastic backing and used two sheets of “stick up” note paper to make a thin backing. I later learned that I could reduce the thickness of the original plastic backing by lightly sanding it with sandpaper.



The keyboard matrix was easily decoded using the methods from my [Instructable](#). It was found to have 8 columns and 16 rows as shown in the table below. The FPC pin number is listed first and the Teensy I/O number is second. Note that FPC pins 1 thru 6 and pins 31 thru 34 are not used by the keyboard. These 10 signals are available for the Teensy to control the touchpad and LED's.

	9-19	10-4	13-17	14-6	17-25	18-8	19-33	23-27
7-20	Caps-lck	a	z	q	1	F1	tab	esc
8-3	cntrl-l							
11-18		shift-l						shift-r
12-5			fn				gui	
15-24	x	tilde		s	2	F3	w	F2
16-7	c		Prt-scrn	d	e	3	F5	F4
20-9	delete		right	period	o	9	L	F12
21-26	v		pause		F6	r	f	4
22-10				alt-l	alt-r			
24-11	;		/	[-	0	p	space
25-28		n	left		F9	Y	h	6
26-12		b		g	t	5	F8	F7
27-32	insert		down	comma	i	8	k	F11
28-31	m		up	j	u	7		F10
29-30	quote	enter]		=	bckspace	
30-29	end	\	menu	Pg-dn	home		Pg-up	

This keyboard has a nice feel and comes from a time before chicklet keys became popular. It only has one Control key and the Delete and Insert keys are located to the right of the space bar. Another oddity is the Windows and Menu keys are in the upper right corner. Some of the Fn-Function keys can't be programmed for USB because there is no human interface device (HID) code for these features. These keys are for adjusting the brightness, zoom, wireless, display mode, hibernation, and standby. Fn-F1 is for security and Fn-F2 is for power usage but they have no HID codes so they have been programmed as volume down and volume up to go along with Fn-Esc which is mute. The other Fn-Function keys still work as described in the Toshiba 2415 [User Manual](#). Fn-F9 toggles the touchpad on and off. Fn-F10 toggles the cursor lock on and off. The cursor key functions are printed on the front left face of the keys surrounding the "i" key. Fn-F11 toggles the number pad on and off. The pad numbers are printed on the front right face of those same keys. Fn-F12 toggles the scroll lock on and off. Most computers don't do anything with this HID code so you won't see any effect if you turn it on other than lighting up the LED.

The HP DV9000 touchpad doesn't do any multi-touch (pinching) operations, just the basics. You can tap the touchpad and it will send a left button click. Normally a touchpad is located under the palms of your hands but this can give unwanted touches so I moved it to the right of the keyboard.

I wrote the Teensy 3.2 code "[Toshiba 2415 kb tp.ino](#)" for this project to implement a USB composite keyboard and touchpad device. In addition to the standard "normal" key layer, there are cursor, number pad, and media key layers in the code. After scanning the keyboard matrix, the Teensy polls the touchpad to see if there has been any cursor movement or button pushes. The overall scan rate is 30 milliseconds.

The picture below is the backside plywood, interior side showing where the Keyboard Scanner Board will be mounted. The other side of this 1/4" 3 ply plywood is stained and varnished for the bottom of the finished assembly.

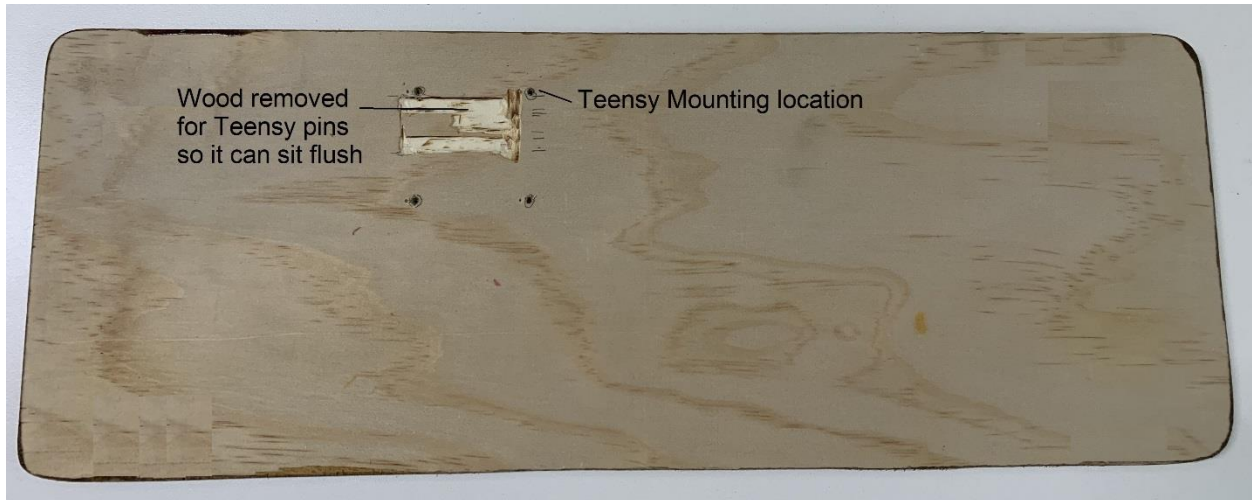

The top side of the middle plywood is shown below. There are cutouts where the Teensy is located and where the Touchpad wires are connected. The LED, Touchpad, and USB wires are routed in two channels made with a Dremel cutting wheel and chisel.

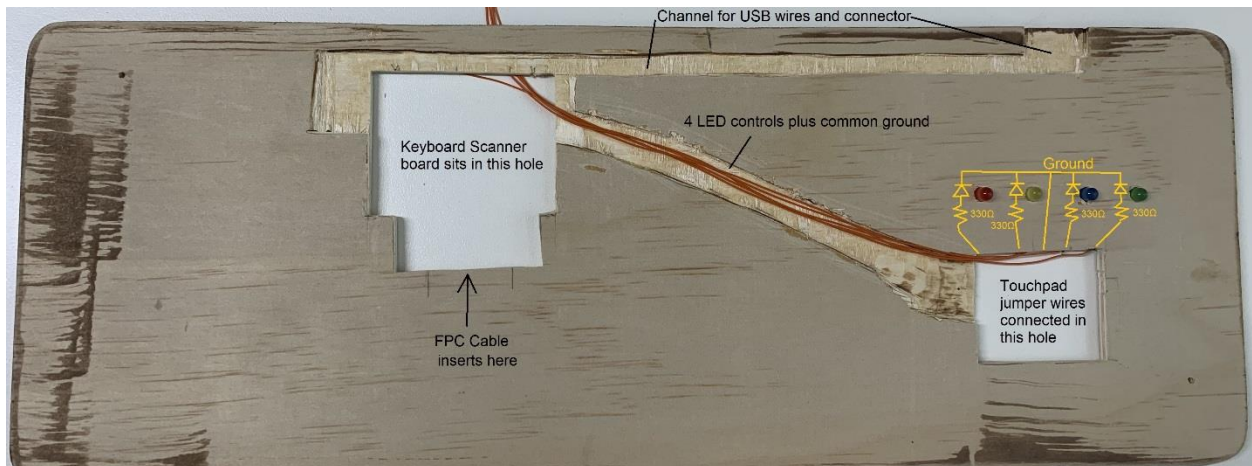

A close up view of the LED wiring is shown below. This is on the middle plywood back side. The LEDs are epoxied in the holes with JB Weld. The LED wires and resistors are placed in cuts made with the Dremel wheel.

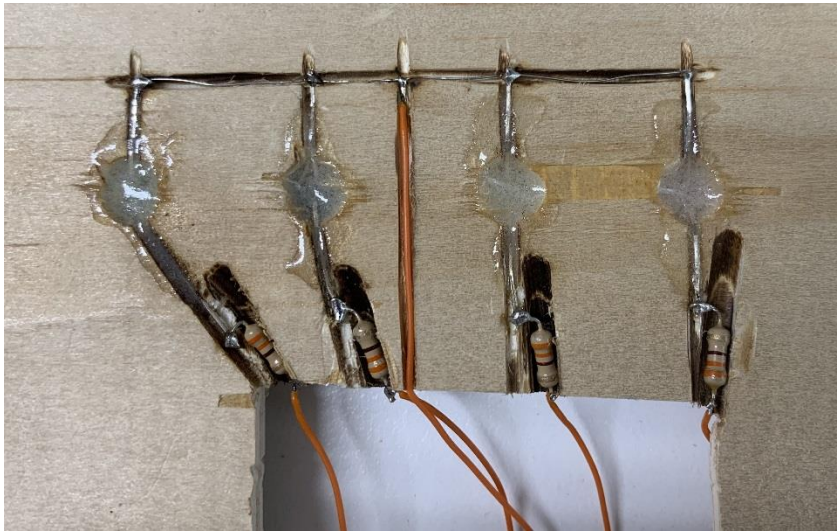

The top plywood is stained and varnished on the keyboard side. The interior side (shown below) has holes for the LEDs and a cutout for access to the Touchpad wires. The FPC cable from the keyboard comes thru a thin slit and then sits in a channel. Clearance for the Teensy is made by chiseling out some of the wood.

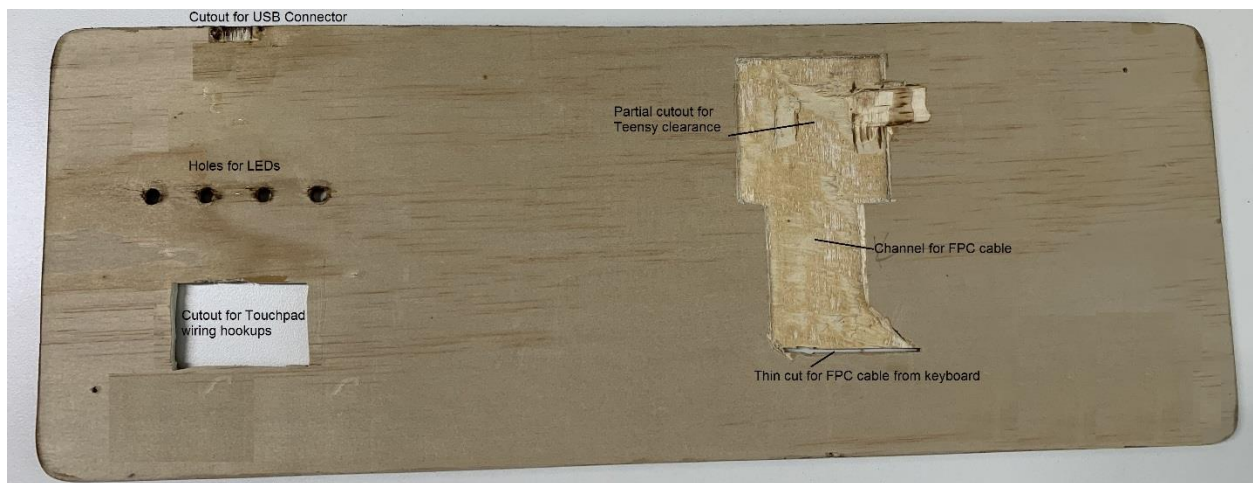

Bottom and middle plywood sheets have been glued together in the picture below. The Teensy Keyboard Scanner board is screwed down and the Adafruit 1833 USB micro B breakout board is wired to a USB micro plug that goes into the Teensy connector. This connector and the reset push button are the high points on the Teensy. Wood was removed from the top plywood at these locations to eliminate any clearance issues. All wires are held in their channels with Kapton tape.

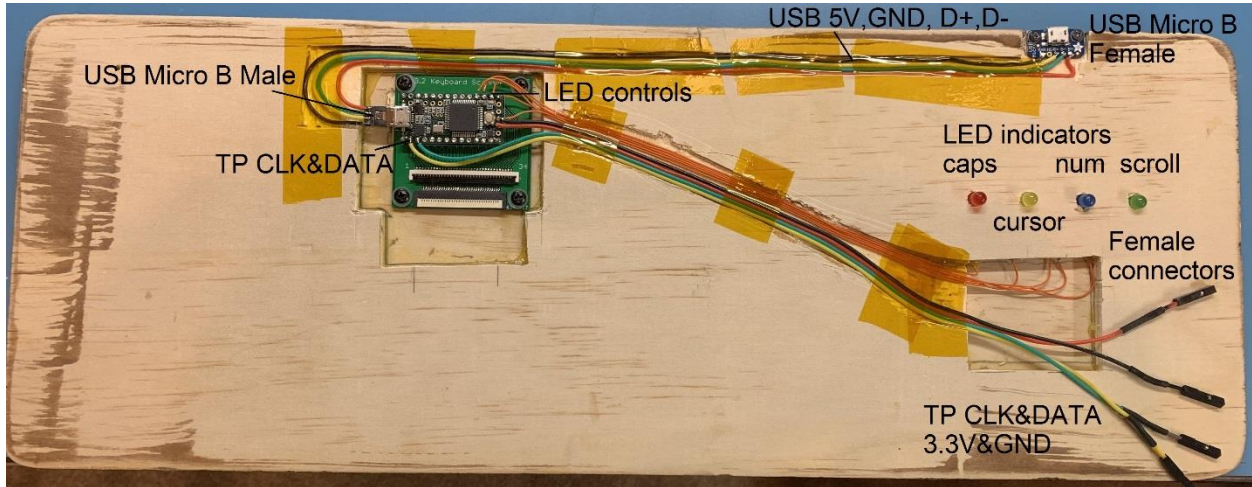

The LED anodes with dropping resistors are soldered to the Teensy as follows:

Caps Lock=Teensy I/O 13

Cursor Lock=Teensy I/O 14

Num Lock=Teensy I/O 15

Scroll Lock=Teensy I/O 16

The 330Ω dropping resistor sets the current for the blue LED at 2ma and 4ma for the other LEDs.

The Touchpad has a 2 wire PS/2 interface plus 3.3 volts and ground from the Teensy. The PS/2 clock is connected to Teensy I/O 0. The PS/2 data is connected to Teensy I/O 1.

The keyboard FPC cable has been inserted thru the slit in the top plywood sheet in the picture below. Once the cable is inserted in the FPC connector, the top plywood can be attached to the other sheets using the screws that hold down the keyboard and touchpad.

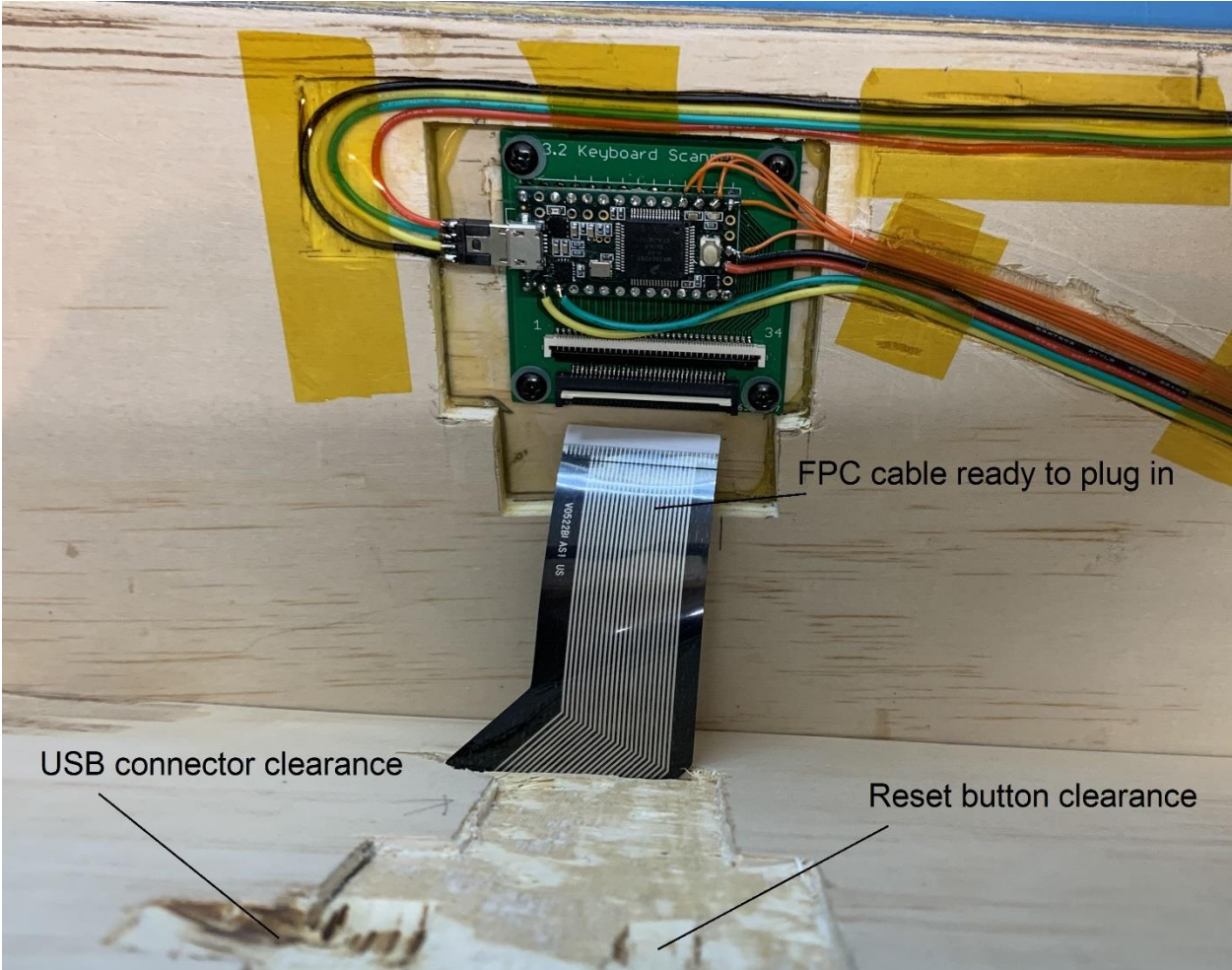

The Synopsys 920-000702-04 touchpad and button board from the HP DV9000 is shown below.

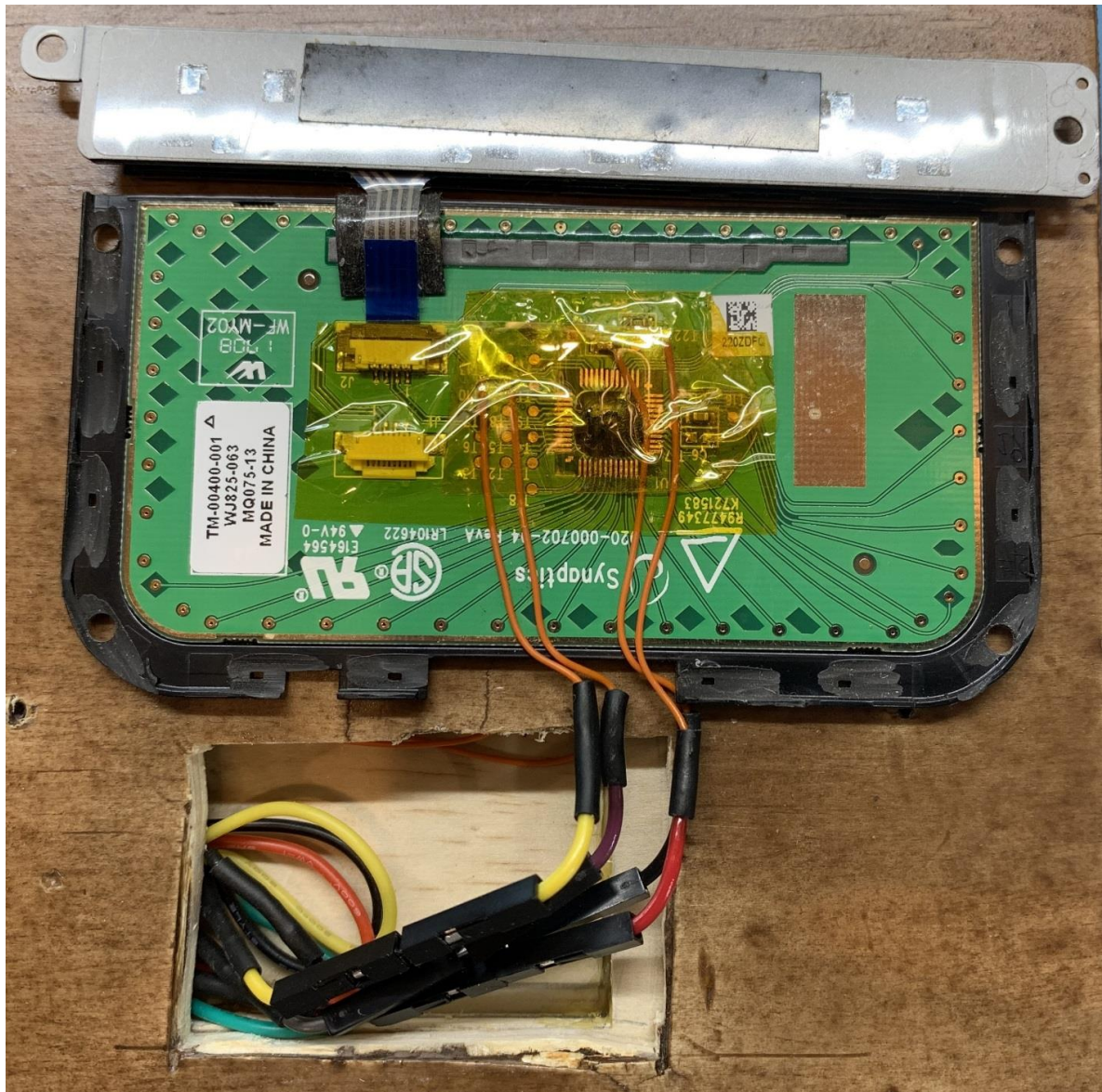

The male and female connectors are hooked up once the top plywood piece is attached. This touchpad has round test points with silkscreen markings as described in my touchpad tutorial at [Hackster.io](https://hackster.io):

T22 = 3.3V

T23 = Gnd

T10 = Clock

T11 = Data

There are active pullups in the main chip for clock and data so no additional PS/2 pullup resistors are required.

The USB Micro B connector on the rear of the assembly is shown below.



This shows the finished keyboard and touchpad attached to the plywood.



The overall dimensions are $16 \frac{5}{8}'' \times 6 \frac{1}{8}'' \times \frac{11}{16}''$. I initially used plastic washers on all the keyboard screws but found they were not needed. Also, washers raise the screw heads up higher, causing them to be felt when pushing the nearby key.

Parts list with pricing and source.

Keyboard from a Toshiba 2415 laptop - [Ebay](#) \$10

Touchpad from an HP DV9000 laptop - [Ebay](#) \$13

Teensy 3.2 with pins - [PJRC](#) \$22.80 plus shipping

Header Kit PRT-13925 - [Sparkfun](#) \$1.50 plus shipping

Keyboard Scanner Board - [JLCPCB](#) \$7 for 5 boards using file [Keyboard Scanner LT2 2020-06-09.zip](#)

34 pin 0.8mm pitch FPC connector - [AliExpress](#) \$5 for 2

USB micro B breakout - [Adafruit](#) \$1.50 plus shipping

USB micro B plug - [Amazon](#) \$3.58 for lot of 10

4 LEDs - [Amazon kit](#) \$0.20 each

4 330Ω resistors - [Amazon kit](#) \$0.03 each

4 male and 4 female jumper connectors cut from kit - [Amazon](#) \$0.05 each

30 gauge wire wrap wire, cut from spool - [Amazon](#) \$0.05

26 gauge stranded wire, cut from spool - [Amazon](#) \$0.05

Finished Plywood 3 ply, 1/4" thick - [Ace Hardware](#) \$19

Other items from my shop: Solder, Flux, Sandpaper, Stain, Varnish, Elmer's wood glue, JB weld epoxy, screws and Kapton tape.

Tools used: Dremel with cutting wheel, drill motor with bits, jig saw, and circular saw.